

> Classic Ready-Made Frames

Assembly instruction for security system



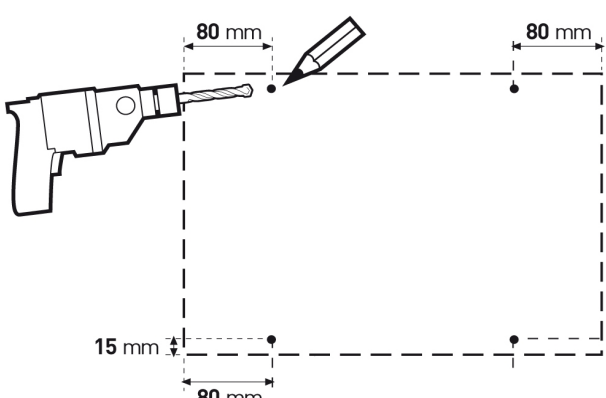
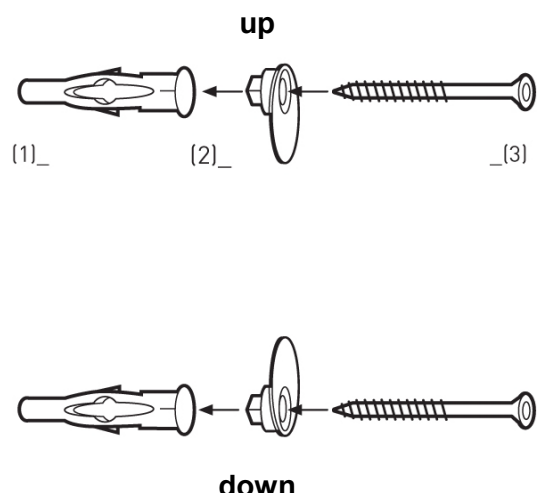
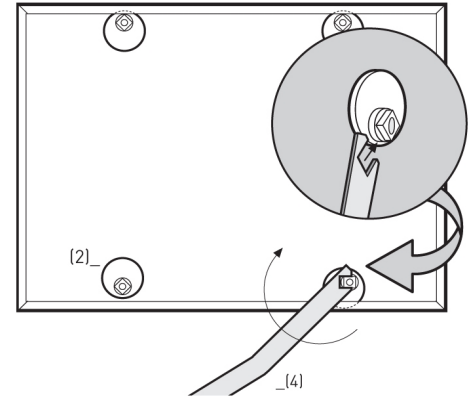

Important: The special key must be ordered separately.

Order-No.: 51713

Special key order-no.: 51714

<p>> 01 Measurement and marking of the drilling distances</p> 	<p>> 02 Fastening the adjusting screws</p> 	<p>> 03 Alignment and securing by adjusting discs</p>  <p>Ready made frame and adjusting screws seen from behind</p>
<p>Mark the desired height of the picture frame. The drilling distances from the outer edges of the interchangeable frame are 80 mm.</p> <p>After hanging up the removable frame (see Fig. 03), mark the lower dimension (15 mm) from the lower edge of the frame and drill. (° 8 mm)</p>	<p>Fasten the hangers (adjusting discs) as shown.</p>	<p>Place the removable frame on the adjusting discs (2) as shown above. Place the special key (4) - between the wall and the removable frame - on the square of the adjustment discs and align the frame horizontally by turning the adjusting discs.</p>

> Parts List

<p>1_Dowels</p>  <p>4 pieces</p>	<p>2_Adjusting discs</p>  <p>4 pieces</p>	<p>3_Oval-head screws</p>  <p>4 pieces</p>	<p>4_Special key</p>  <p>1 piece</p>
---	--	---	---

> Aluminium - Cut

Assembly instruction for security system





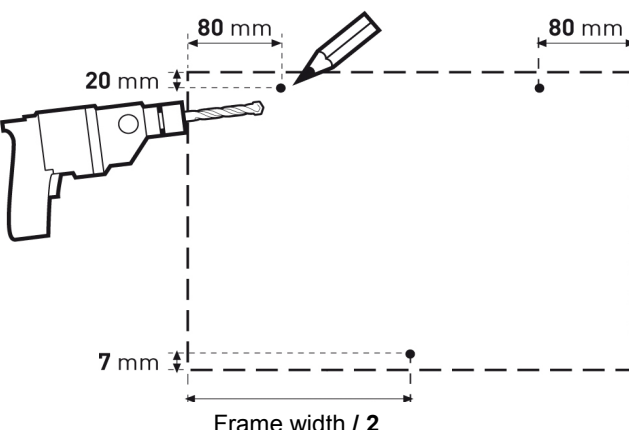
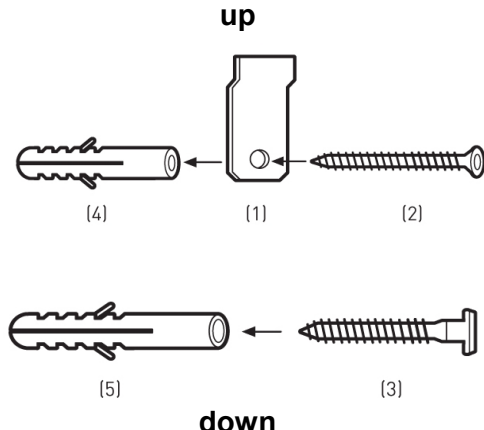
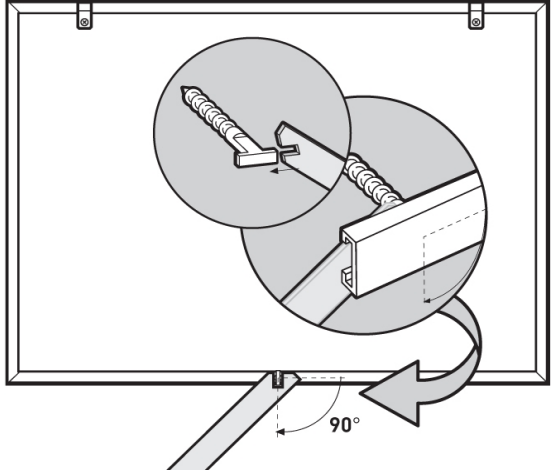

Important: The special key must be ordered separately.

Order-No.: 51703

Special key order-no.: 51714

<p>> 01 Measurement and marking of the drilling distances</p> 	<p>> 02 Fastening the hangers and the safety catch</p> 	<p>> 03 Tightening the screw locking device</p> 
<p>Mark the desired height of the picture frame on the wall. The drilling distances from the outer edges of the frame are 80 mm x 20 mm (° 6 mm).</p> <p>The (3) screw lock is placed in the middle of the frame, 7 mm from the lower edge (° 8 mm).</p>	<p>Attach the (1) hanger and (3) screw lock to the wall as shown.</p>	<p>After hanging up the frame only the screw lock has to be tightened with the special wrench.</p>

> Parts List

<p>1_Hanger 2 pieces</p> 	<p>2_Oval-head screws 2 pieces</p> 	<p>3_Screw lock (hammer-head bolt) 1 piece</p> 	<p>4_Hexagon dowel 2 pieces</p> 	<p>5_Eight dowel 1 piece</p> 	<p>6_Special key 1 piece</p> 
--	--	---	---	--	--

> Wood - Cut

Assembly instruction for security system



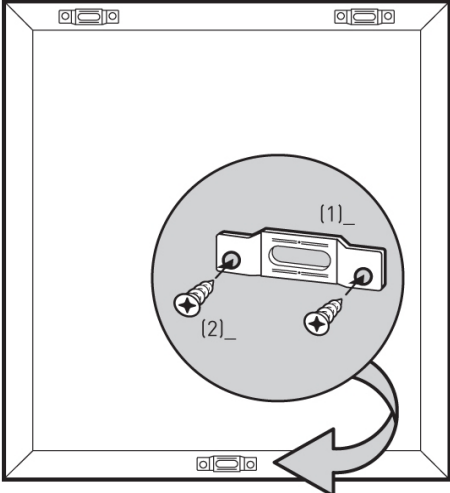
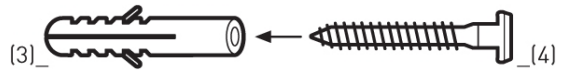
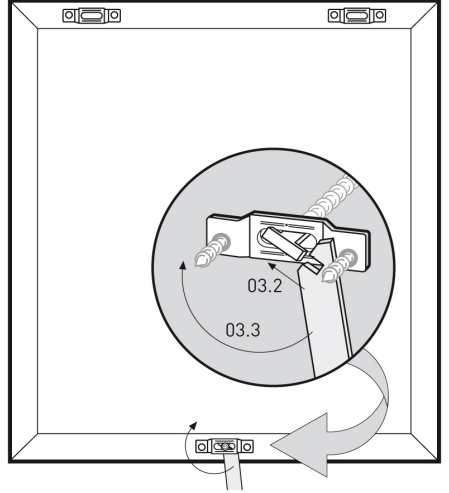

Important: The special key must be ordered separately.

Order-No.: 51705

Special key order-no.: 51714

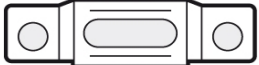
<p>> 01 Measurement and marking of the drilling distances</p> 	<p>> 02 Fastening the screw locking devices</p> 	<p>> 03 Alignment and securing by adjusting discs</p> 
<p>Screw the special fittings (1) onto the wooden frame as shown above using pan-head screws (2).</p> <p>Mark and drill the desired height of the picture frame (° 8 mm).</p>	<p>Insert the dowels (3) into the holes ° 8 mm. Screw the screw locks (4) into the dowels as far as they will go, that the outer surface of the screw locking devices up to the wall is approx. 5 mm. Bring the screw locking devices into horizontal position.</p>	<p>03.1 Put the picture frames with the special fittings on the horizontally screwed in screw locks (4).</p> <p>03.2 Grasp into the screw neck with the special wrench (5) and 03.3 Move the screw locking devices into the vertical position. The frame is secured.</p>

> Parts List

<p>1_Special fittings</p>  <p>3 pieces</p>	<p>2_Oval-head screws</p>  <p>6 pieces</p>	<p>3_Dowels</p>  <p>3 pieces</p>	<p>4_Screw fuse</p>  <p>3 pieces</p>	<p>5_Special key</p>  <p>1 piece</p>
---	---	--	---	---